

# HS-100I防爆本安加速度传感器

AC 加速度 输出 通过 硅胶防水电缆

## 主要性能

- 防爆本安型
- 用于数据采集
- 可定制的功能

## 应用领域

大型机械，纸浆和造纸，采矿，金属，航空航天，汽车，水，制药，风能，轴承，发动机，压缩机等等

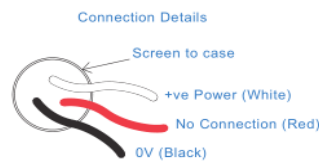
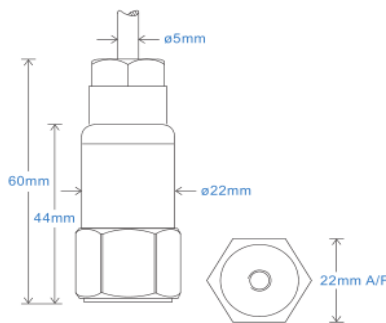

## 技术性能

基座共振	参见产品选型表
灵敏度	请参阅：产品选型表 ±10% 额定 80Hz 在 22°C 温度下
频率响应	2Hz (120cpm) to 10kHz (600kcpm) ± 5% 1.5Hz (90cpm) to 12kHz (720kcpm) ± 10% 0.8Hz (48cpm) to 15kHz (900kcpm) ± 3dB
隔离	基座隔离
范围	请参阅：产品选型表
横向灵敏度	小于5%

## 机械参数

材质	不锈钢
感应原件	压电陶瓷/压缩
安装扭矩大小	8Nm
重量	106g
电缆选型	请参阅产品选型表
连接器	请参阅产品选型表
螺纹安装	请参阅产品选型表

## 电气参数

电压:	18-30Volts DC
电气噪声	0.1mg max
电流范围	0.5mA to 8mA
偏电压	10 - 12 Volts DC
建立时间	2 seconds
输出阻抗	200 Ohms max.
Case Isolation	>10 <sup>8</sup> Ohms at 500 Volts

## 应用环境

环境温度	参考防爆等级
防护等级	IP68
最大振动	5000g
EMC	EN61326-1:2013

## 频率响应 (at 100mV/g)

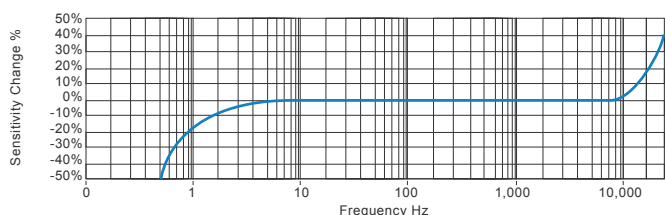

## 应用领域

风能，电动机，泵，压缩机，离心机，输送机，空气处理机，齿轮箱，辊，干燥机，压力机，冷却，VAC，主轴，机床，工艺设备

Vibration sensor should be firmly fixed to a flat surface (spot face surface may be needed to be produced and cable anchored to sensor body.)

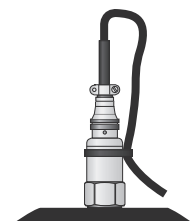

## 产品选型表

<b>产品名称</b> HS - Hansford Sensors	<b>产品系列</b> 100I - 防爆本安工业振动传感器										
<div style="display: flex; justify-content: space-around; font-size: 24px; font-weight: bold;"> <span>H</span><span>S</span><span>1</span><span>0</span><span>0</span><span>X</span><span>X</span><span>X</span><span>X</span><span>X</span><span>X</span><span>X</span> </div>											
<b>附加选项</b> M - 矿用防爆本安 (Group I) I - 防爆本安 (Group II) L - 316L 不锈钢材质 S - 侧面输出 Y - ±5% 灵敏度 IC3 - IC3 防爆	<b>灵敏度</b> 010 - 10mV/g 030 - 30mV/g 050 - 50mV/g 100 - 100mV/g	<b>范围</b> ±800g ±250g ±160g ±80g	<b>共振频率</b> 34kHz (2,040kcpm) 33kHz (1,980kcpm) 32kHz (1,920kcpm) 30kHz (1,800kcpm)	<b>电缆/接插件</b> 01 - PUR耐油电缆 02 - 屏蔽铠装电缆 07 - 硅胶防水电缆 50 - 2 Pin MS接插件 54 - M12接插件	<b>安装螺纹</b> 01 - 1/4-28" UNF Female 02 - 1/4-28" UNF Male 05 - Quick Fit Female 06 - M6 x 1mm Male 08 - M8 x 1.25mm Male 10 - M10 x 1.5mm Male						



T: 150 210 98804  
www.hansfordsensors.com.cn  
汉施弗德传感器（上海）有限公司



## Intrinsically Safe Requirements

Maximum Cable Length	See <a href="http://www.hansfordsensors.com.cn">www.hansfordsensors.com.cn</a> see attached system drawing	Australian Approval Group I	IECEX ITA 11.0013X Ex ia I Ma (-55°C ≤ Ta ≤ +110°C)
Certificate details: Group I	IECEX BAS07.0037X Baseefa07ATEX0149X ⓈI M1 Ex ia I Ma (-55°C ≤ Ta ≤ +110°C)	US/Canada Approvals Class I, II, III, Division 1, 2, Groups A - G, T4, -55°C to +110°C, IP65 Class I, Zone 0, AEx, ia, IIC, T4, Ga, -55°C to +110°C Zone 20, AEx, ia, IIIC, T130°C, IP65, Da, -55°C to +110°C	Certificate No. USTC/15/FAI/01350
Certificate details: Group II (ignition temperature 130°C)	IECEX BAS07.0035X Baseefa07ATEX0144X ⓈII 1GD Ex ia IIC T4 Ga Ex ia IIIC T130°C IP65 Da (-55°C ≤ Ta ≤ +110°C)	Class I, II, III, Division 1, 2, Groups A - G, T6, -55°C to +60°C Class I, Zone 0, AEx, ia, IIC, T6, Ga, -55°C to +60°C Zone 20, AEx, ia, IIIC, T80°C, IP65, DA, -55°C to +60°C	Certificate No. MASC S/16-0231X Group II (As Baseefa/ATEX) MASC M/16-0230X Group I (As Baseefa/ATEX)
Certificate details: Group II (ignition temperature 80°C)	IECEX BAS07.0035X Baseefa07ATEX0144X ⓈII 1GD Ex ia IIC T6 Ga Ex ia IIIC T80°C IP65 Da (-55°C ≤ Ta ≤ +60°C)	South African Approval Korean Approval Group II	Certificate No. MASC S/16-0231X Group I (As Baseefa/ATEX) Certificate No 19-AV4BO-0048X Ex ia IIC T6/T4 T6 -55°C < Ta < +60°C T4 -55°C < Ta < +110°C
Accelerometer System Certificate	Baseefa07Y0145 Ex ia IIC T6 (-55°C ≤ Ta ≤ +60°C) Ex ia IIC T4 (-55°C ≤ Ta ≤ +110°C) On request - consult Sales Office	Terminal Parameters Connector	Ui = 28V, li = 93mA, Pi = 0.65W Ci = 1.0nf Li = 0
Terminal Parameters	Ui = 28V, li = 93mA, Pi = 0.65W Ci = 83nf Li/Ri = 15.4μH/Ohm	System Connections	see attached system drawings
500V Isolation	Units Will Pass A 500V Isolation Test	Barrier	1 x Pepperl + Fuchs Galvanic Isolator KFD2-VR4-Ex1.26 (BAS02ATEX7206) see attached system drawings 1 x MTL Zener Barrier MTL7728+ (BAS01ATEX7217) or Pepperl + Fuchs Zener Barrier Z728 (BAS01ATEX7005) or any other barrier that conforms to system drawings on website
Certified Temperature Range	Ex ia IIC T6 Ga (-55°C ≤ Ta ≤ +60°C) (Gas) Ex ia IIIC T80°C IP65 Da (-55°C ≤ Ta ≤ +60°C) (Dust) Ex ia IIC T4 Ga (-55°C ≤ Ta ≤ +110°C) (Gas)* Ex ia IIIC T130°C IP65 Da (-55°C ≤ Ta ≤ +110°C) (Dust)* Ex ia I Ma (-55°C ≤ Ta ≤ +110°C) (Mining) *On request - consult Sales Office	Notes: Special conditions of safe use for Group I & II. The free end of the cable on the integral cable version of the apparatus must be terminated in an appropriate dust-proof enclosure.	

## Intrinsically Safe Requirements for IC3 Variations

HS-100IC3 Variation is certified as Category 3 equipment. These sensors are only certified for use within Zones 2.	Certified Temperature Range	Ex ic IIC T4 Gc (-55°C ≤ Ta ≤ +110°C)
	Terminal Parameters	Ui = 25.2V, li = 146mA, Pi = 0.92W Ci = 83nf Li 66μH
Certificate Details: Group II (ignition temperature 130°C)	500V Isolation	Units will pass a 500V Isolation Test
IECEX BAS17.0054X Baseefa7ATEX0069X eII 3G Ex ic IIC T4 Gc (-55°C ≤ Ta ≤ +110°C)	Special Conditions of Use:	The Ci and Li parameters listed on the equipment certificate must be taken into account when connecting this equipment.

## Certifications



This product is certified in accordance with  
UL 913, 8th Ed. Rev. December 6, 2013  
CAN/CSA C22.2 No. 157-92 (R2012) +Upd1 +Upd2



T: 150 210 98804

[www.hansfordsensors.com.cn](http://www.hansfordsensors.com.cn)

汉施弗德传感器（上海）有限公司



Non-hazardous area apparatus which is unspecified except that it must not be supplied from nor contain under normal or abnormal conditions, a source of potential with respect to earth in excess of 250 volts DC, under normal conditions the potential at the connections to the galvanic isolator must not exceed 40 volts DC.

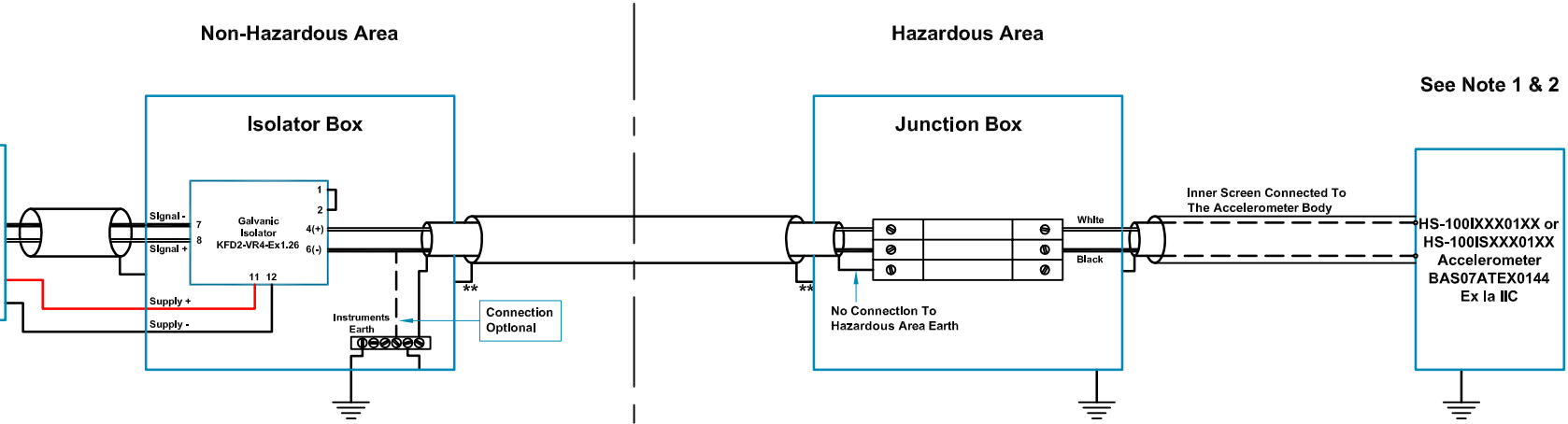

**Table 1: Cable Parameters For Additional Cable Lengths**

Accelerometer With Integral Cable Length ≤ 10m		
Group	Capacitance $\mu\text{F}$	L/R Ratio $\mu\text{H}/\Omega$
IIC	0.086	46
IIB	0.730	172
IIA	2.470	363
Accelerometer With Integral Cable Length ≤ 50m		
Group	Capacitance $\mu\text{F}$	L/R Ratio $\mu\text{H}/\Omega$
IIC	0.051	46
IIB	0.695	172
IIA	2.435	363
Accelerometer With Integral Cable Length ≤ 92m		
Group	Capacitance $\mu\text{F}$	L/R Ratio $\mu\text{H}/\Omega$
IIC	0.013	46
IIB	0.657	172
IIA	2.397	363

### Hansford Sensors Ltd

HS-100I or HS-100IS  
Accelerometer System

Ex ia IIC T4 (-55°C ≤ Ta ≤ +110°C) or  
Ex Ia IIC T6 (-55°C ≤ Ta ≤ +60°C)

#### Notes:

- The capacitance and inductance, to resistance ratio (L/R) of hazardous area cable, must not exceed the values shown in Table 1.
- The cable from the accelerometer to the junction box must not be installed in a high velocity dust laden atmosphere
- The installer is to perform a risk assessment in accordance with clause 10 of EN 60079-25 and install lightning protection arrestors as deemed necessary.

Rev No	DRF No	Date Drg	Drg By	Appd By	Material: N/A
A	Release	15/06/07	MJS	CMH	

Tolerances Unless Stated  
 0 or 0.0 ±0.5  
 0.00 ±0.15  
 Angle ±5°  
 1.6/√ Finish All Over  
 Threads g6 H6



Hansford Sensors Ltd  
 Artisan, Hillbottom Rd  
 Sands Industrial Estate  
 High Wycombe  
 Bucks HP12 4HJ

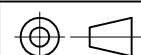

Do Not Scale

All Dimensions In mm Unless  
 Otherwise Stated

**If In Doubt - Ask!**

Description: System Connections  
 For HS-100I & HS-100IS Group II  
 Accelerometers With 2 Pin MS Connector  
 F.U.W. Galvanic Isolation

Drawing No: M06-056-A

Scale: NTS  
 Sheet: 1 of 2

Form Number:  
 QF024 Issue 1

Non-hazardous area apparatus which is unspecified except that it must not be supplied from nor contain under normal or abnormal conditions, a source of potential with respect to earth in excess of 250 volts rms or 250 volts dc. under normal conditions the potential at the connections to the zener barrier must not exceed 40 volts dc.

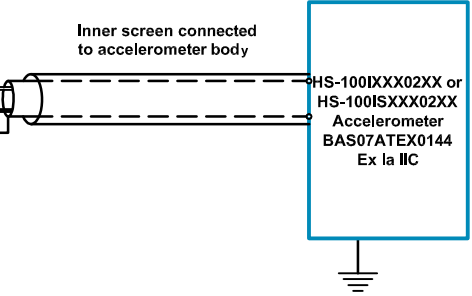
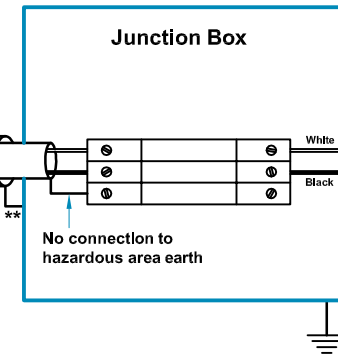
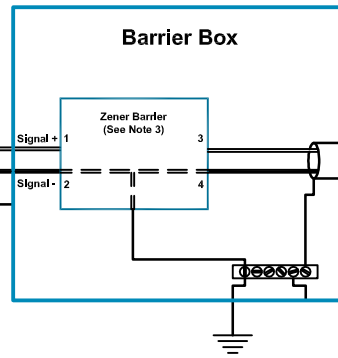

**Table 1: Cable Parameters For Additional Cable Lengths**

**Accelerometer With Integral Cable Length ≤ 10m**

Group	Capacitance $\mu\text{F}$	L/R Ratio $\mu\text{H}/\Omega$
IIC	0.073	56
IIB	0.239	168
IIA	0.654	448

**Accelerometer With Integral Cable Length ≤ 50m**

Group	Capacitance $\mu\text{F}$	L/R Ratio $\mu\text{H}/\Omega$
IIC	0.038	56
IIB	0.204	168
IIA	0.619	448

**Accelerometer With Integral Cable Length ≤ 92m**

Group	Capacitance $\mu\text{F}$	L/R Ratio $\mu\text{H}/\Omega$
IIC	0.000	56
IIB	0.166	168
IIA	0.581	448

**Hansford Sensors Ltd**

HS-100I or HS-100IS Accelerometer System

Ex ia IIC T4 (-55°C ≤ Ta ≤ +110°C) or Ex ia IIC T6 (-55°C ≤ Ta ≤ +60°C)

**Notes:**

- The capacitance and inductance, to resistance ratio (L/R) of hazardous area cable, must not exceed the values shown in Table 1.
- The cable from the accelerometer to the junction box must not be installed in a high velocity dust laden atmosphere.
- Any single zener diode safety barrier certified by an approved body to [Ex ia] IIC having the following output parameters: Uo = 28V dc, Io = 93mA dc, Po = 0.65W. e.g. MTL7728 to BAS01ATEX7217 or Pepperl + Fuchs Z728 to BAS01ATEX7005.
- The installer is to perform a risk assessment in accordance with clause 10 of EN 60079-25 and install lightning protection arrestors as deemed necessary.

Rev No	DRF No	Date Drg	Drg By	Appd By	Material: N/A
A	Release	16/09/15	MJS	CMH	
					Tolerances Unless Stated
					0 or 0.0 ±0.5
					0.00 ±0.15
					Angle ±5°
					1.6/ Finish All Over Threads g6 H6



Hansford Sensors Ltd  
Artisan, Hillbottom Rd  
Sands Industrial Estate  
High Wycombe  
Bucks HP12 4HJ

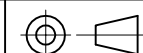

Do Not Scale

All Dimensions In mm Unless Otherwise Stated

**If In Doubt - Ask!**

Description: System Connections For HS-100I & HS-100IS Group II Accelerometers With 2 Pin MS Connector F.U.W. Zener Barrier

Drawing No: M06-056-A

Scale: NTS  
Sheet: 2 of 2

Form Number: QF024 Issue 1